

Entity/Relationship Modelling

Database Systems Lecture 4

Munawar, PhD

In This Lecture

- Entity/Relationship models
 - Entities and Attributes
 - Relationships
 - Attributes
 - E/R Diagrams
- For more information
 - Connolly and Begg chapter 11
 - Ullman and Widom chapter 2

Database Design

- Before we look at how to create and use a database we'll look at how to design one
- Need to consider
 - What tables, keys, and constraints are needed?
 - What is the database going to be used for?
- Conceptual design
 - Build a model independent of the choice of DBMS
- Logical design
 - Create the database in a given DBMS
- Physical design
 - How the database is stored in hardware

Entity/Relationship Modelling

- E/R Modelling is used for conceptual design
 - Entities - objects or items of interest
 - Attributes - facts about, or properties of, an entity
 - Relationships - links between entities
- Example
 - In a University database we might have entities for Students, Modules and Lecturers. Students might have attributes such as their ID, Name, and Course, and could have relationships with Modules (enrolment) and Lecturers (tutor/tutee)

Entity/Relationship Diagrams

- E/R Models are often represented as E/R diagrams that
 - Give a conceptual view of the database
 - Are independent of the choice of DBMS
 - Can identify some problems in a design

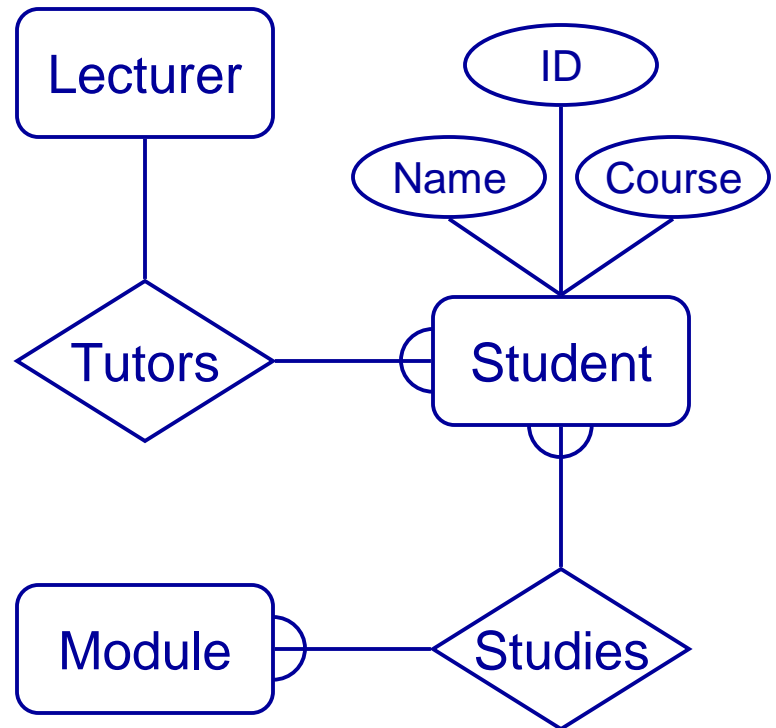

Entities

- Entities represent objects or things of interest
 - Physical things like students, lecturers, employees, products
 - More abstract things like modules, orders, courses, projects
- Entities have
 - A general type or class, such as Lecturer or Module
 - Instances of that particular type, such as Steve Mills, Natasha Alechina are instances of Lecturer
 - Attributes (such as name, email address)

Diagramming Entities

- In an E/R Diagram, an entity is usually drawn as a box with rounded corners
- The box is labelled with the name of the class of objects represented by that entity

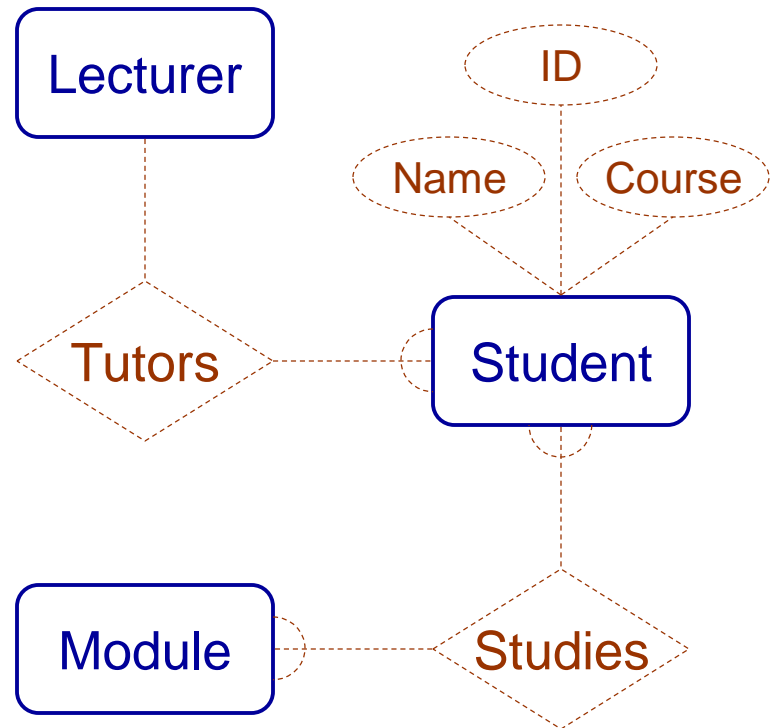

Attributes

- Attributes are facts, aspects, properties, or details about an entity
 - Students have IDs, names, courses, addresses, ...
 - Modules have codes, titles, credit weights, levels, ...
- Attributes have
 - A name
 - An associated entity
 - Domains of possible values
 - Values from the domain for each instance of the entity they are belong to

Diagramming Attributes

- In an E/R Diagram attributes may be drawn as ovals
- Each attribute is linked to its entity by a line
- The name of the attribute is written in the oval

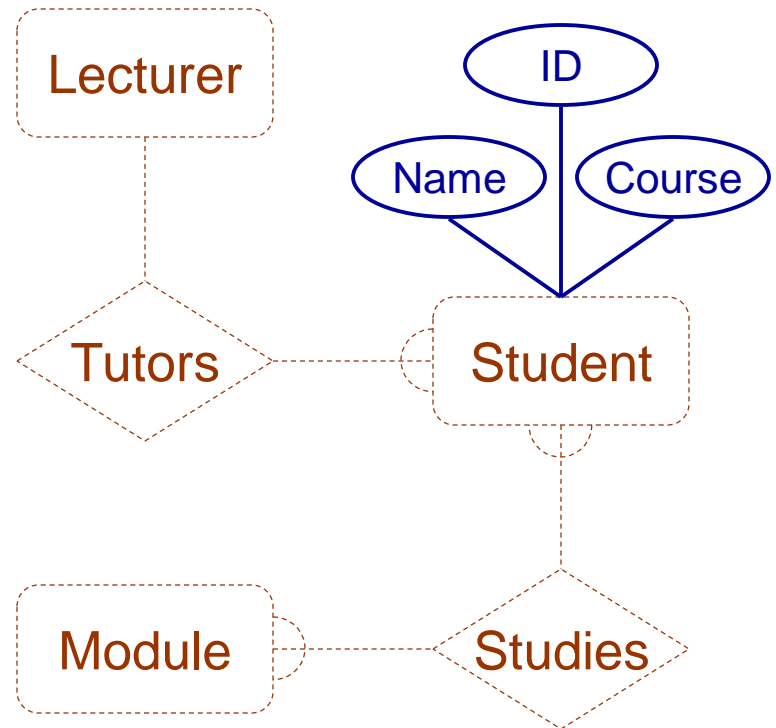

Relationships

- Relationships are an association between two or more entities
 - Each Student takes several Modules
 - Each Module is taught by a Lecturer
 - Each Employee works for a single Department
- Relationships have
 - A name
 - A set of entities that participate in them
 - A degree - the number of entities that participate (most have degree 2)
 - A cardinality ratio

Cardinality Ratios

- Each entity in a relationship can participate in zero, one, or more than one instances of that relationship
- This leads to 3 types of relationship...
- One to one (1:1)
 - Each lecturer has a unique office
- One to many (1:M)
 - A lecturer may tutor many students, but each student has just one tutor
- Many to many (M:M)
 - Each student takes several modules, and each module is taken by several students

Diagramming Relationships

- Relationships are links between two entities
- The name is given in a diamond box
- The ends of the link show cardinality

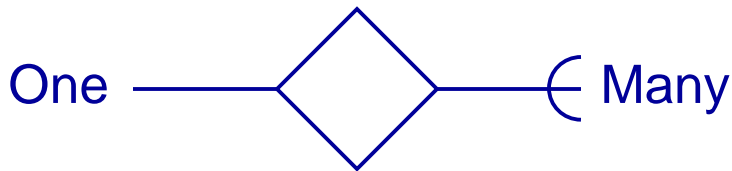

Entity Relationship Modelling

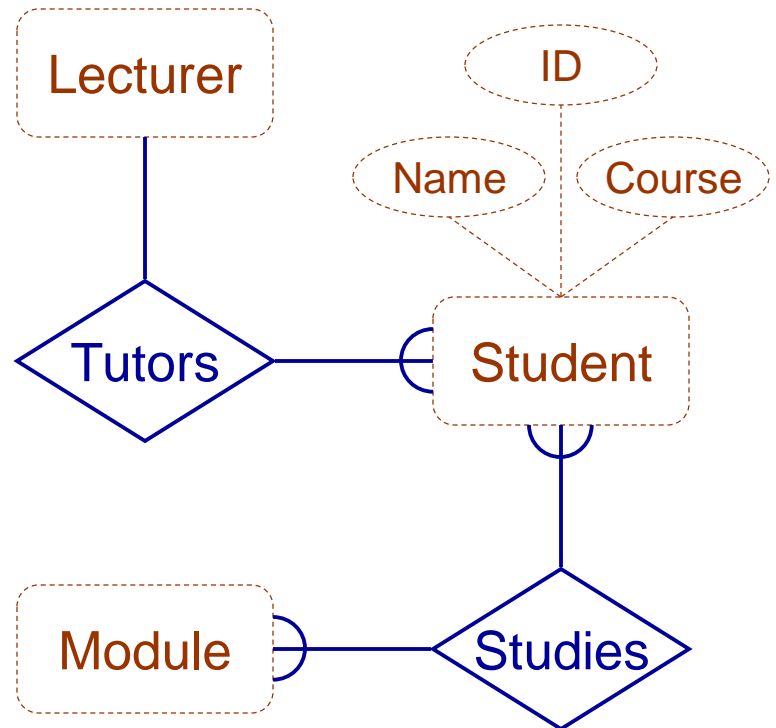

Removing M:M Relationships

- Many to many relationships are difficult to represent
- We can split a many to many relationship into two one to many relationships
- An entity represents the M:M relationship

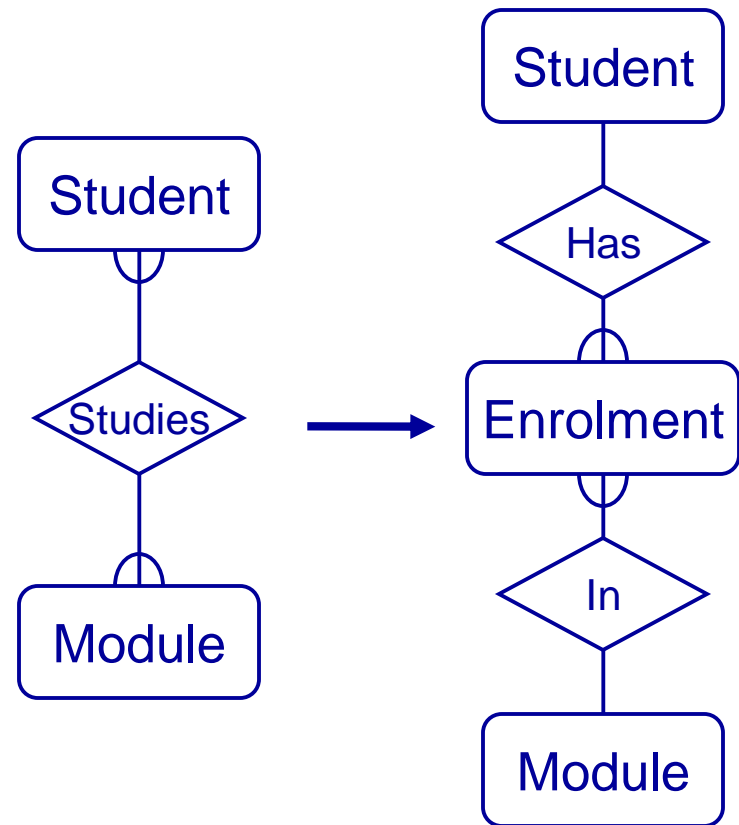

Making E/R Models

- To make an E/R model you need to identify
 - Entities
 - Attributes
 - Relationships
 - Cardinality ratios
- from a description
- General guidelines
 - Since entities are things or objects they are often nouns in the description
 - Attributes are facts or properties, and so are often nouns also
 - Verbs often describe relationships between entities

Example

A university consists of a number of departments. Each department offers several courses. A number of modules make up each course. Students enrol in a particular course and take modules towards the completion of that course. Each module is taught by a lecturer from the appropriate department, and each lecturer tutors a group of students

Example - Entities

A university consists of a number of **departments**. Each department offers several **courses**. A number of **modules** make up each course. **Students** enrol in a particular course and take modules towards the completion of that course. Each module is taught by a **lecturer** from the appropriate department, and each lecturer tutors a group of students

Example - Relationships

- A university consists of a number of departments. Each department **offers** several courses. A number of modules **make up** each course. Students **enrol in** a particular course and **take** modules towards the completion of that course. Each module is **taught by** a lecturer **from the** appropriate department, and each lecturer **tutors** a group of students

Example - E/R Diagram

Entities: Department, Course, Module, Lecturer, Student

Department

Course

Module

Lecturer

Student

Example - E/R Diagram

Each department offers several courses

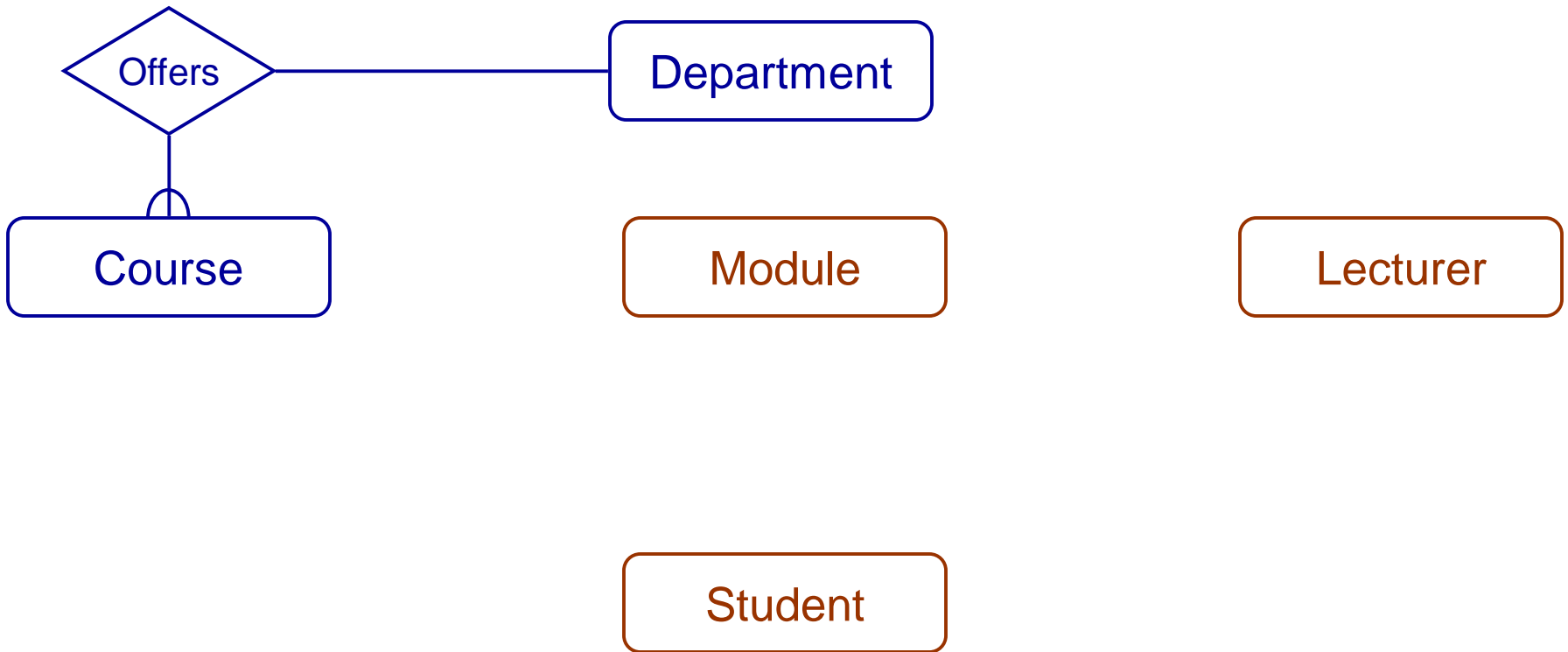

Example - E/R Diagram

A number of modules **make up** each courses

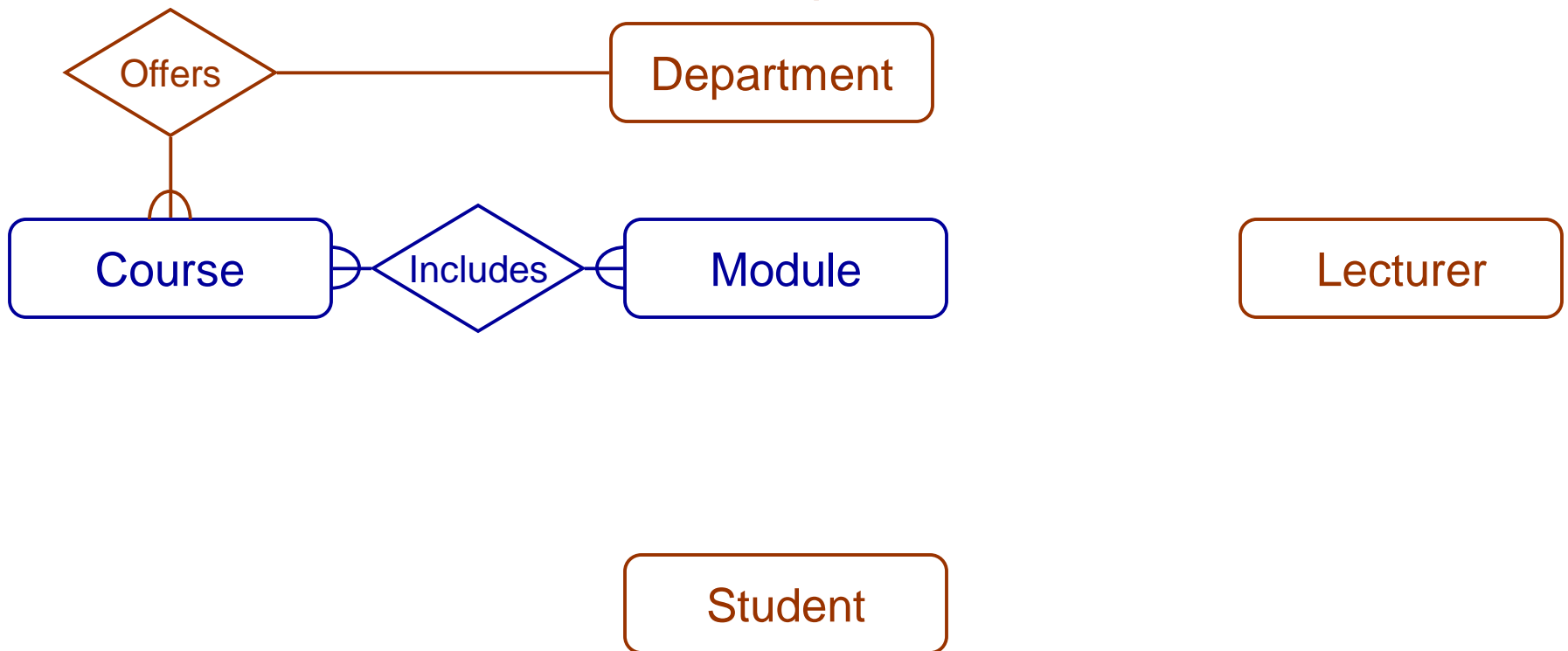

Example - E/R Diagram

Students **enrol** in a particular course

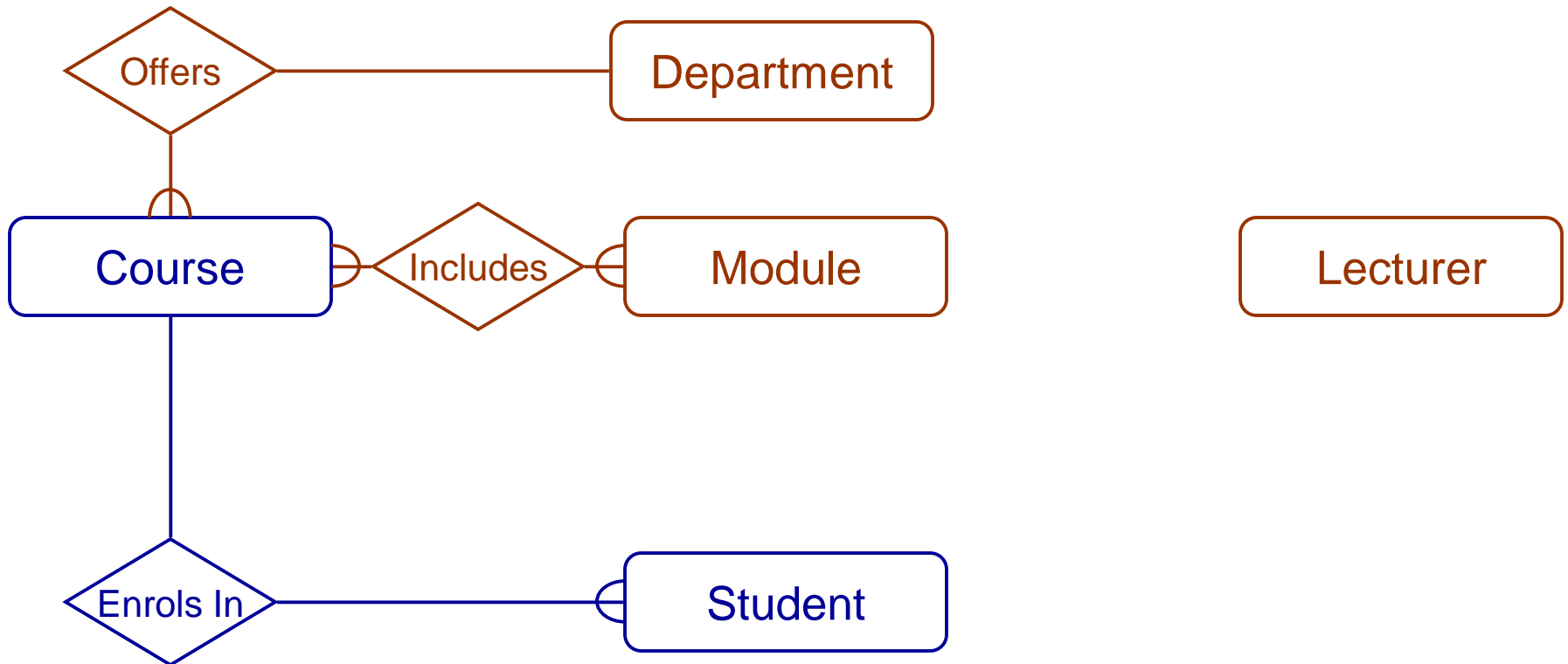

Example - E/R Diagram

Students ... take modules

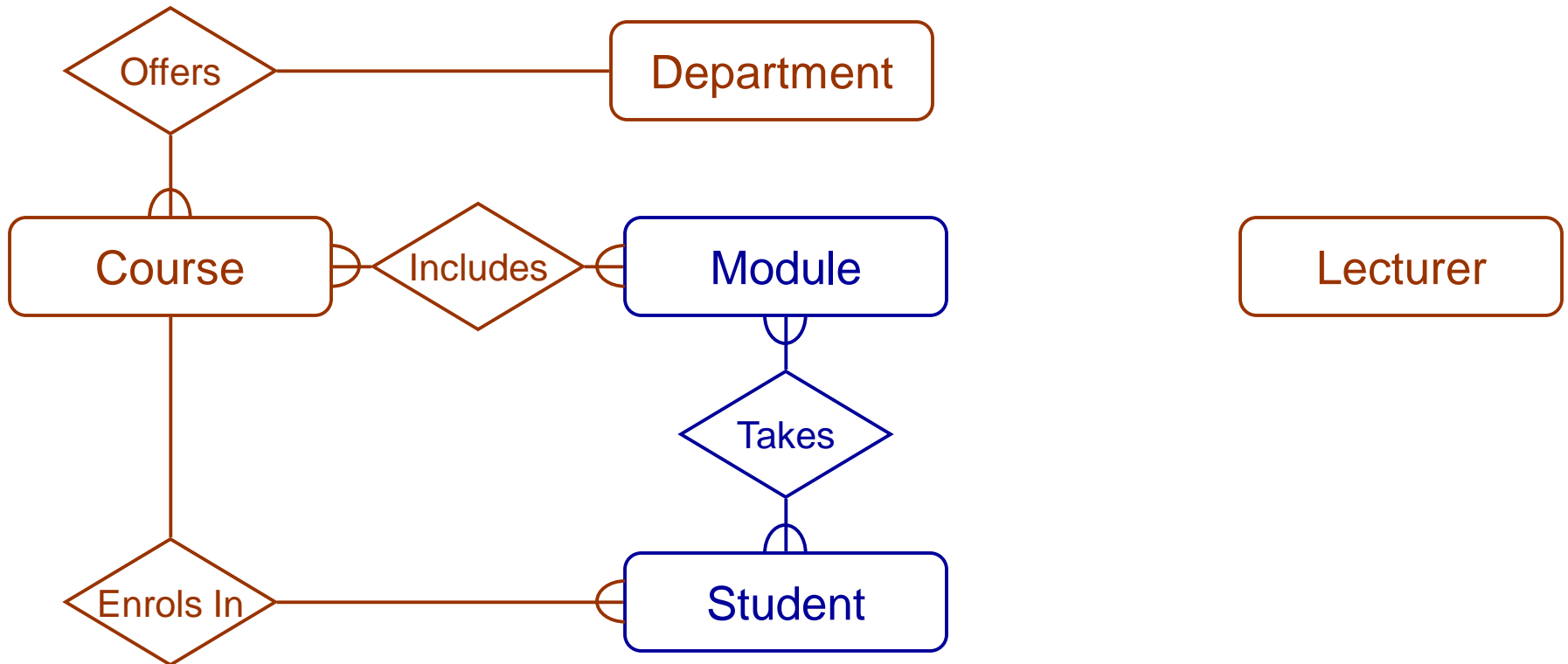

Example - E/R Diagram

Each module is taught by a lecturer

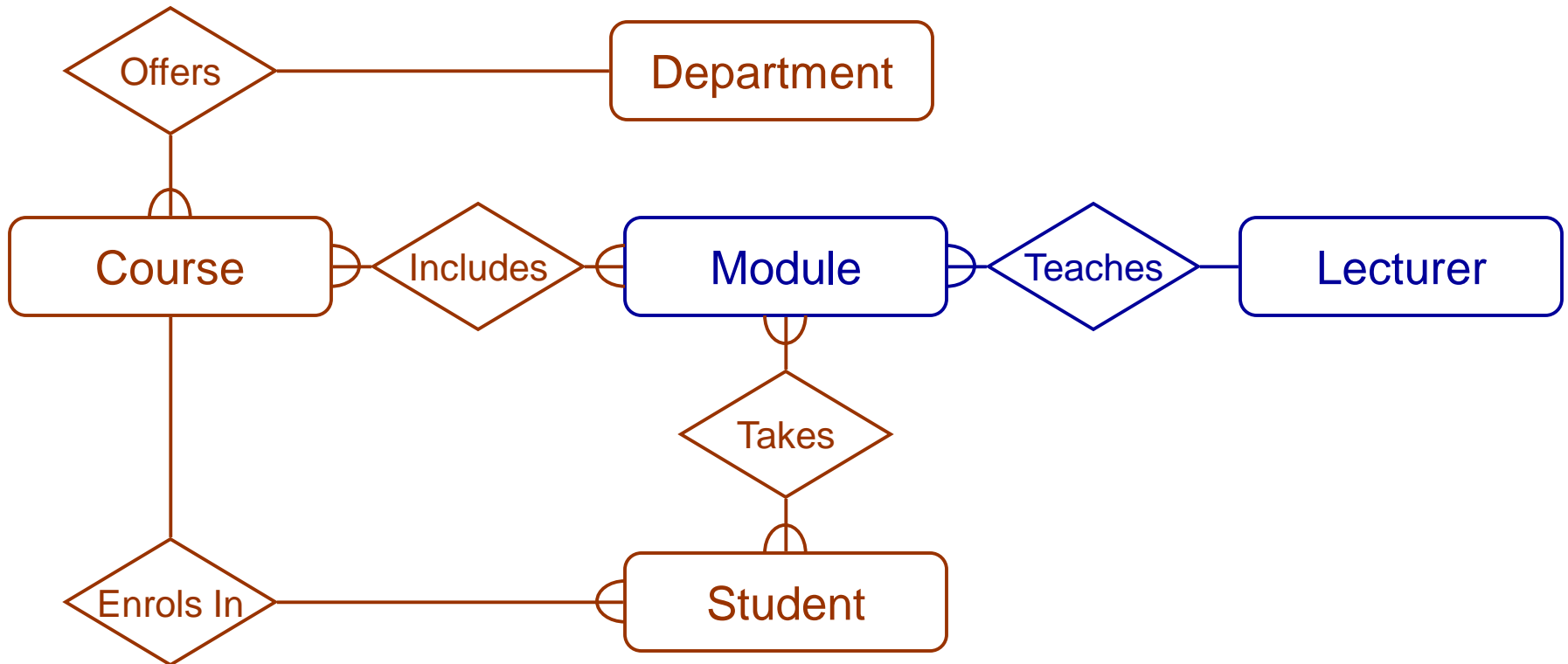

Example - E/R Diagram

a lecturer from the appropriate department

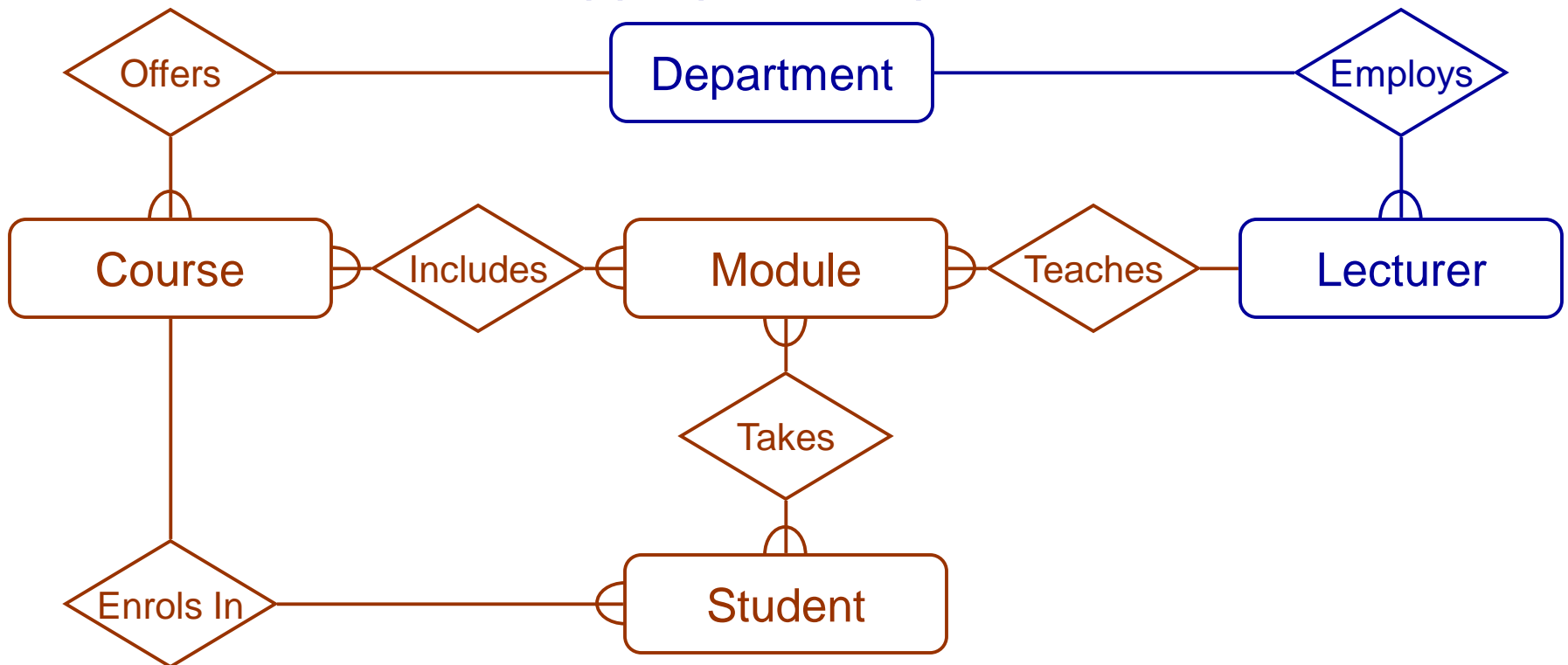

Example - E/R Diagram

each lecturer **tutors** a group of students

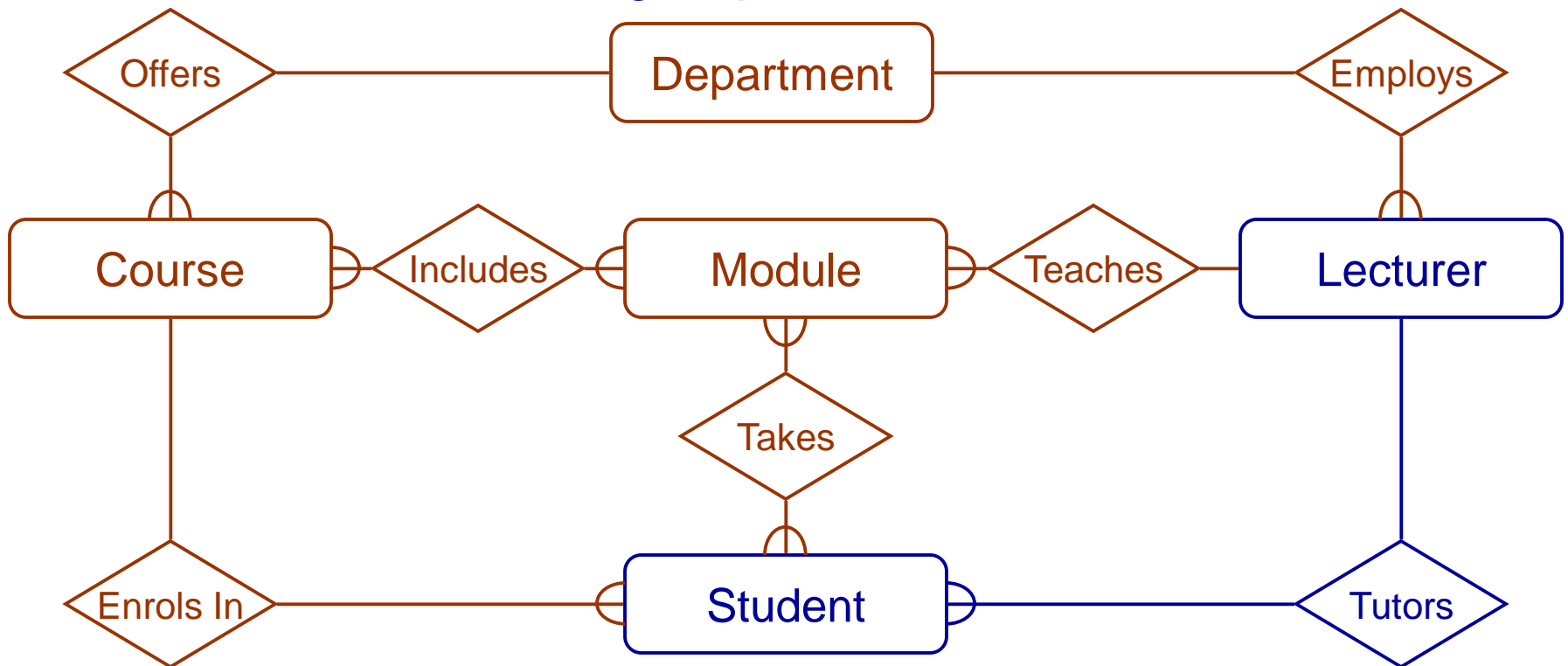

Example - E/R Diagram

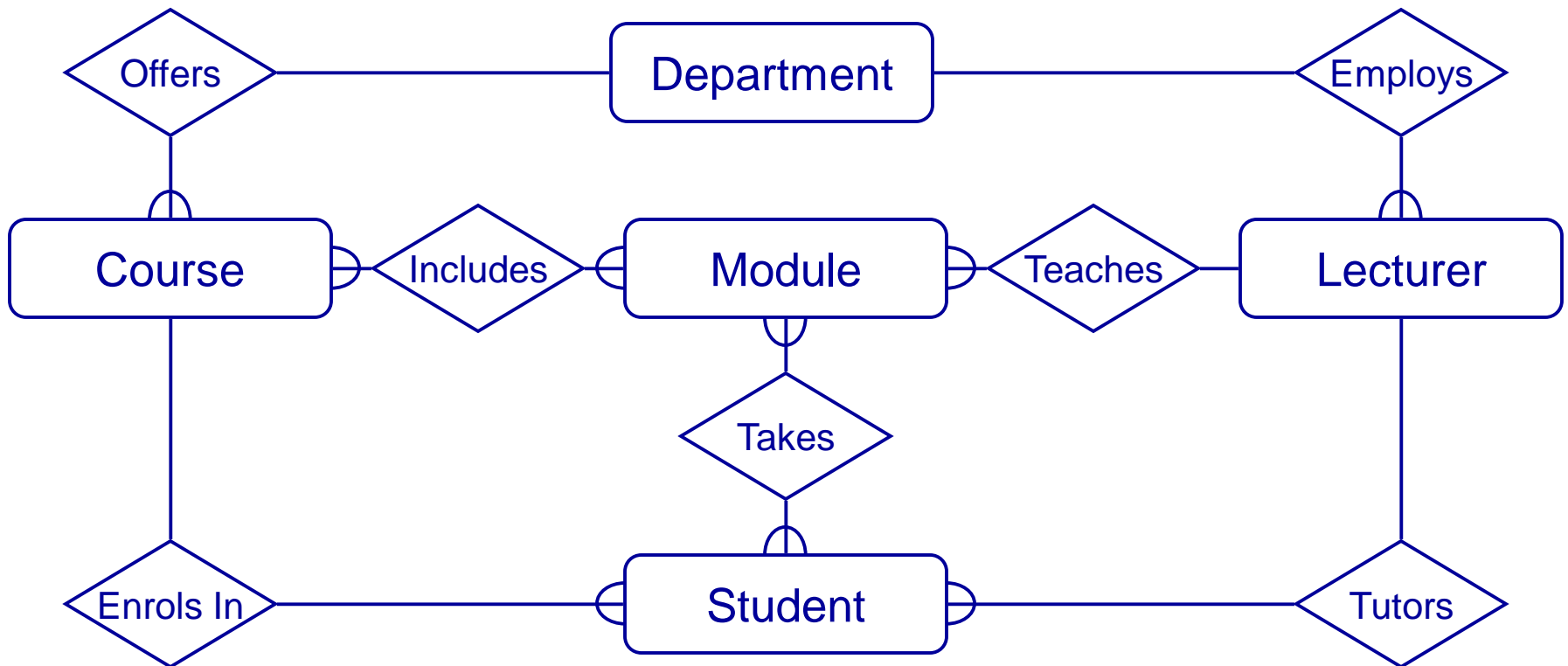

Entities and Attributes

- Sometimes it is hard to tell if something should be an entity or an attribute
 - They both represent objects or facts about the world
 - They are both often represented by nouns in descriptions
- General guidelines
 - Entities can have attributes but attributes have no smaller parts
 - Entities can have relationships between them, but an attribute belongs to a single entity

Example

We want to represent information about products in a database. Each product has a description, a price and a supplier. Suppliers have addresses, phone numbers, and names. Each address is made up of a street address, a city, and a postcode.

Example - Entities/Attributes

- Entities or attributes:
 - product
 - description
 - price
 - supplier
 - address
 - phone number
 - name
 - street address
 - city
 - postcode
- Products, suppliers, and addresses all have smaller parts so we can make them entities
- The others have no smaller parts and belong to a single entity

Example - E/R Diagram

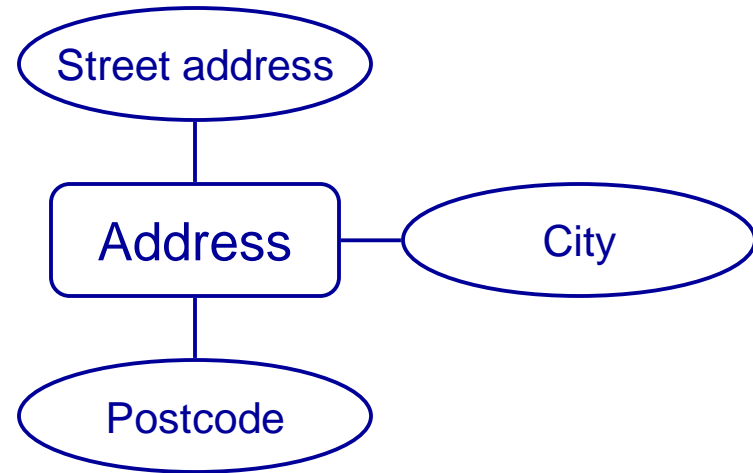
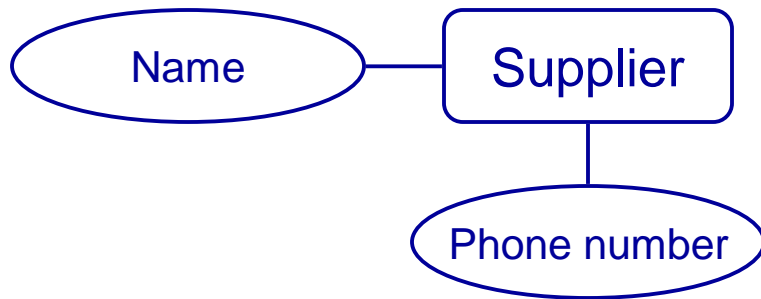
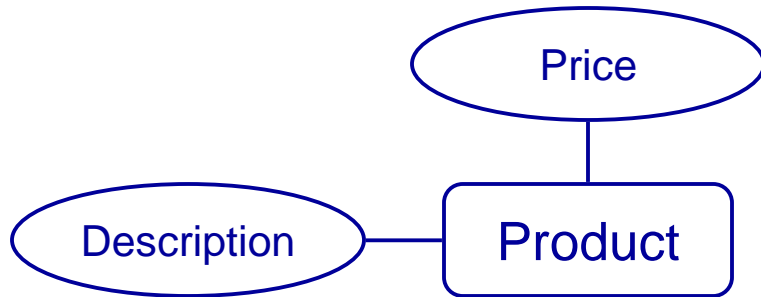

Example - Relationships

- Each product has a supplier
 - Each product has a single supplier but there is nothing to stop a supplier supplying many products
 - A many to one relationship
- Each supplier has an address
 - A supplier has a single address
 - It does not seem sensible for two different suppliers to have the same address
 - A one to one relationship

Example - E/R Diagram

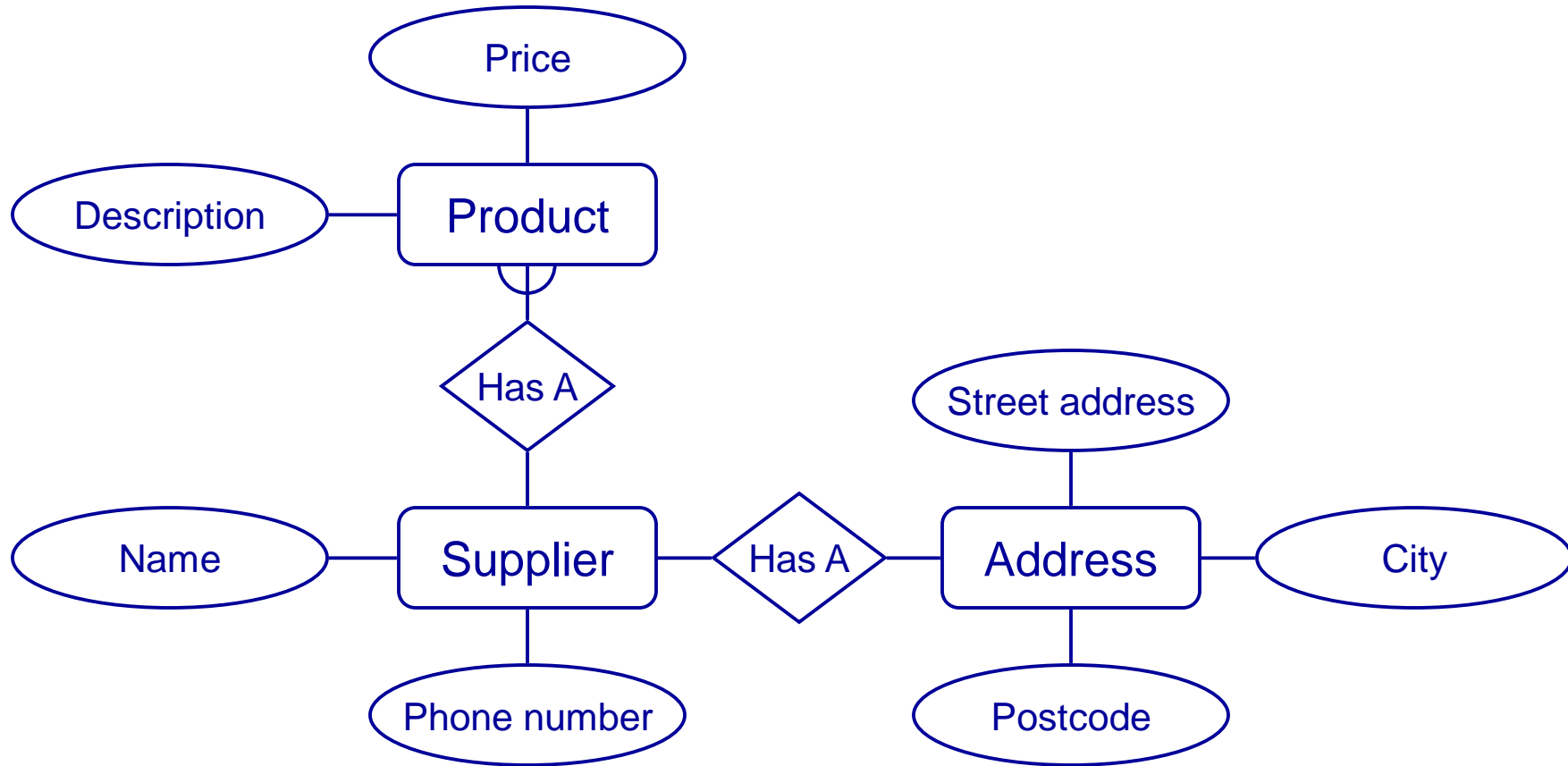

One to One Relationships

- **Some** relationships between entities, A and B, **might** be redundant if
 - It is a 1:1 relationship between A and B
 - Every A is related to a B and every B is related to an A
- Example - the supplier-address relationship
 - Is one to one
 - Every supplier has an address
 - We don't need addresses that are not related to a supplier

Redundant Relationships

- We can merge the two entities that take part in a redundant relationship together
 - They become a single entity
 - The new entity has all the attributes of the old one

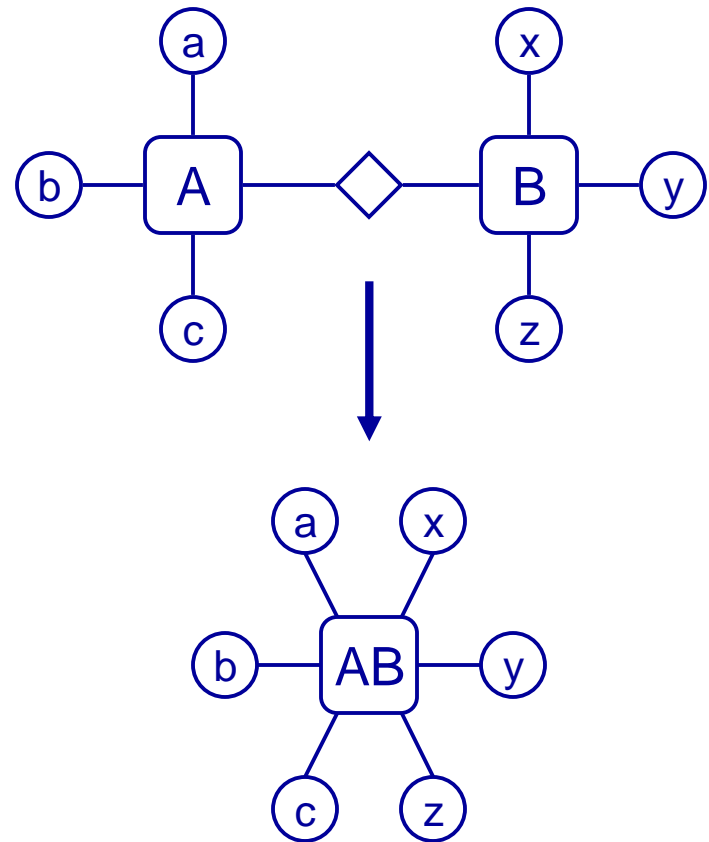

Example - E/R Diagram

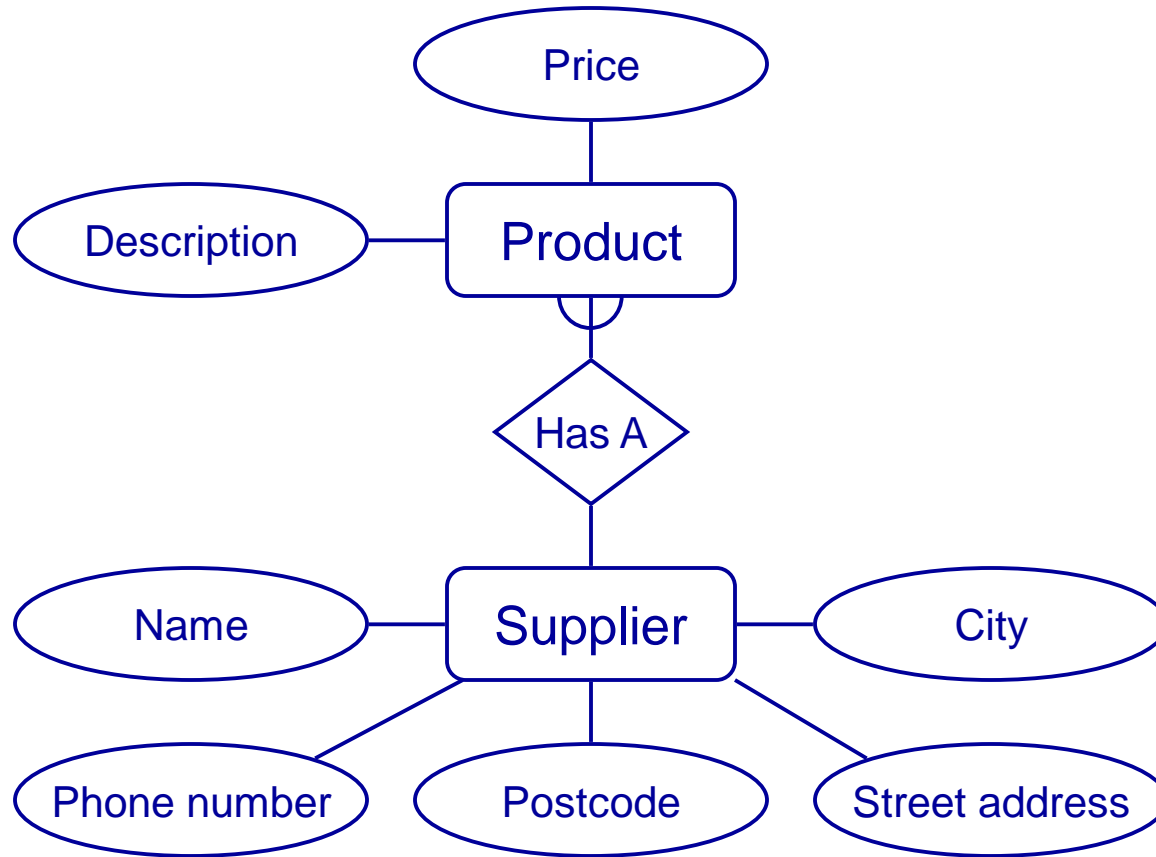

Making E/R Diagrams

- From a description of the requirements identify the
 - Entities
 - Attributes
 - Relationships
 - Cardinality ratios of the relationships
- Draw the E/R diagram and then
 - Look at one to one relationships as they might be redundant
 - Look at many to many relationships as they might need to be split into two one to many links

Debugging Designs

- With a bit of practice E/R diagrams can be used to plan queries
 - You can look at the diagram and figure out how to find useful information
 - If you can't find the information you need, you may need to change the design

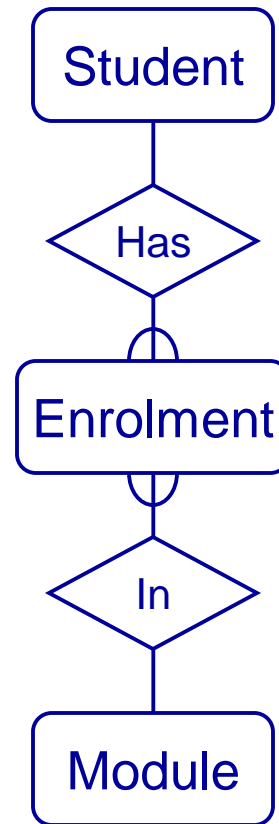

How can you find a list of students who are enrolled in Database systems?

Debugging Designs

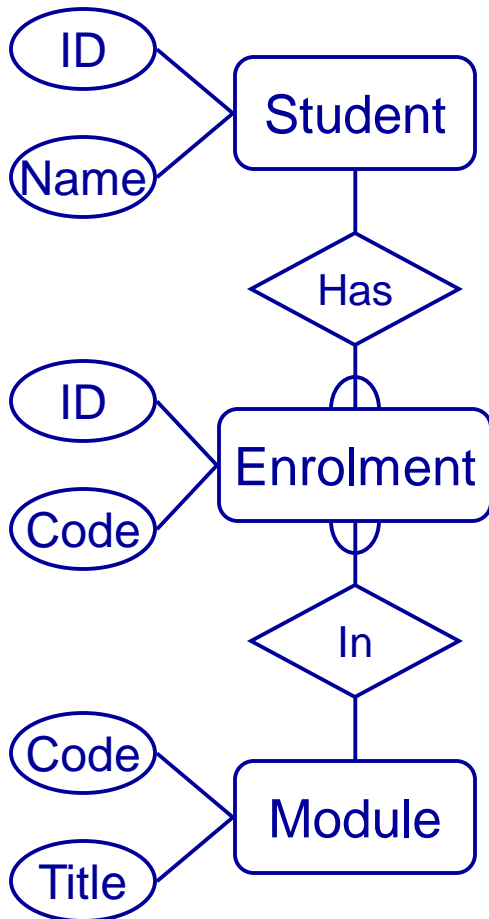

(3) For each instance of Enrolment in the result of (2) find the corresponding Student

(2) Find instances of the Enrolment entity with the same Code as the result of (1)

(1) Find the instance of the Module entity with title 'Database Systems'

This Lecture in Exams

“A database will be made to store information about patients in a hospital. On arrival, each patient’s personal details (name, address, and telephone number) are recorded where possible, and they are given an admission number. They are then assigned to a particular ward (Accident and Emergency, Cardiology, Oncology, etc.). In each ward there are a number of doctors and nurses. A patient will be treated by one doctor and several nurses over the course of their stay, and each doctor and nurse may be involved with several patients at any given time.”

This Lecture in Exams

Identify the *entities, attributes, relationships, and cardinality ratios* from the description.

(4 marks)

Draw an entity-relationship diagram showing the items you identified.

(4 marks)

Many-to-many relationships are hard to represent in SQL tables. Explain why many-to-many relationships cause problems in SQL tables, and show how these problems may be overcome.

(4 marks)

Next Lecture

- SQL
 - The SQL language
 - SQL, the relational model, and E/R diagrams
 - CREATE TABLE
 - Columns
 - Primary Keys
 - Foreign Keys
- For more information
 - Connolly and Begg chapter 6
 - Ullman and Widom chapter 6.5, 6.6